

操作手冊



SAM

2.2KW 5.5KW



SHANGHAI HANBELL PRECISE MACHINERY CO.,LTD.

108

TEL/FAX:021-57350280/021-51368588
<http://www.hanbell.com.cn>

E-mail:hanbell-sales@hanbell.cn



操作手冊



12

12

Thank you for using Hanbell products.

All Hanbell products are through quality and performance control tests prior to delivery. However, the guaranty period for oil-free scroll air end is based on the product within 12 months after the completion of installation and commissioning at the first job-site or within 12 months from the date of delivery from the Hanbell



,



操作手冊

1	5
1.1	5
1.2	5
1.3	5
1.4	7
1.5	7
2	7
2.1	7
2.2	7
2.3	7
2.4	8
3	9
3.1	9
3.2	9
3.3	9
3.4	10
4	11
4.1	11
4.2	11
4.3	11
4.4	11
4.5	12
4.6	12
4.7	15
5	16
.	17



操作手冊

1

1.1

SAM-285 SAM-440 SAM-700

SAM-440-08 SAM 440 L/min 08

bar.g

S/N

1.2

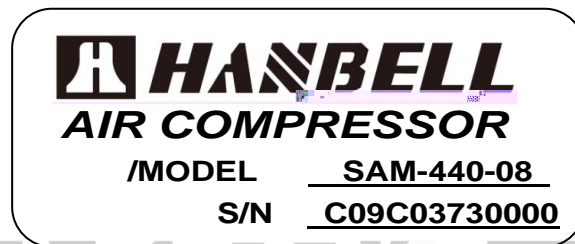

1.3

1.3.1

- A.
- B.
- C.

1.3.2

A.

-
-
-

B.

:

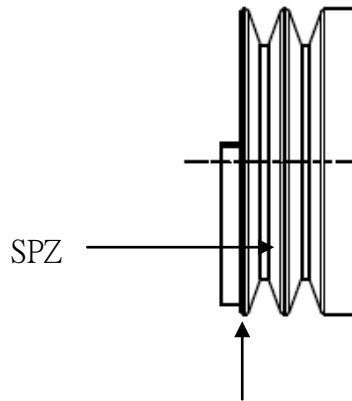

- V DIN7753 PART1 / ISO 4184
- ISO 1940-G6.3 VDI2060-Q6.3 ISO 8821 “ ”
- DIN 2211 GB/T

13575.1-2008



- 180

- 0.02mm

-
-

C.

0.2m

15m

0~40

50%

6

操作手冊

1.4

SAM “ ”

1.5

2

2.1.



2.2.

- GB/T 6388
- GB/T 13384
- GB/T 3853
- GB/T 15847
- JB 8524
- GB/T 7777
- GB/T 4980
- JB/T 6441

2.3.

2.4.



“

”

“

”



HANBELL



3HP 30HP

1

SAM-440

SAM-700



2

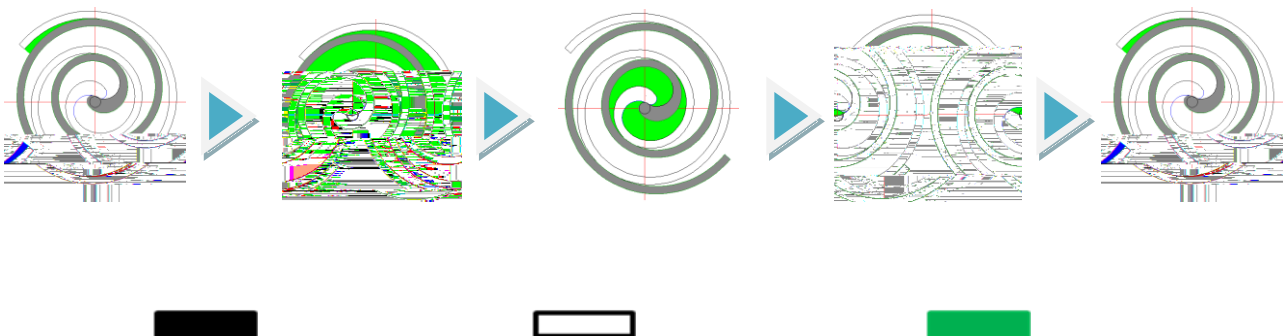

3.4

Oil-free scroll air end technical data

Model	Shaft power	Rated pressure	Air displacement	Exhaust interface	Speed	Noise value	Outline size	Weight
	KW	Mpa	L/min	inch	r/min	dB(A)	mm	kg
SAM-285	2.2	0.8	250	PT3/8"	2840	64	270x300x265	15.5
	2.4	1.0	215		2400			
SAM-440	3.75	0.8	410	PT1/2"	3050	65	347x330x295	19.5
	4.4	1.0	355		3000			
SAM-700	5.5	0.8	570	PT3/4"	2950	66	335x381x357	31.5
	6.0	1.0	490		2650			



4.

4.1

1 5% 3%

2

3 600

KW	1.1~1.5	3.7~5.5	11~15	22~30
MM ²	2~2.5	4	6~10	25

4 100

4.2



4.3

- 1
- 2
- 3
- 4

4.4

- 1
- 2
- 3
- 4
- 5
- 6
- 7

1~2s

操作手冊

8

9

10

11

4.5

1

2

0MPa

3

0MPa

4



4.6

1

2

3

4

1

GB/T14295-2019

99%

500

1500~2500

2

3

4

5

1

2

3

4

5

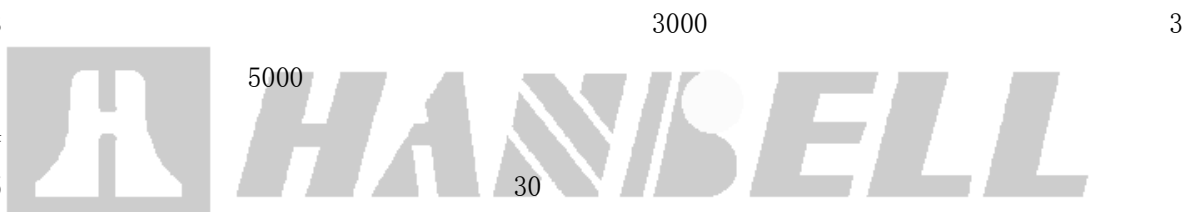

0.8MPa

+45

		500	2500	5000	10000	15000	20000	
		2		2	4	6	8	
								3500h
								2500h
								6

		500	2500	5000	10000	15000	20000	
		2		2	4	6	8	
								2500h
								2500h
								2500h
								6



4.7

	<ol style="list-style-type: none">1.2.3.4.5.6.7.8.	<ol style="list-style-type: none">1.2.3.4.5.6.7.8.
	<ol style="list-style-type: none">1.2.3.4.5.	<ol style="list-style-type: none">1.2.3.4.5.
	<ol style="list-style-type: none">1.2.3.4.	<ol style="list-style-type: none">1.2.3.4.
	<ol style="list-style-type: none">1.2.3.4.	<ol style="list-style-type: none">1.2.3.4.
	<ol style="list-style-type: none">1.2.3.4.5.6.	<ol style="list-style-type: none">1.2.3.4.5.6.
	<ol style="list-style-type: none">123	<ol style="list-style-type: none">123

1

a.

b.

c.

2

a.

b.

c.

3

a.

b.

c.

4



5



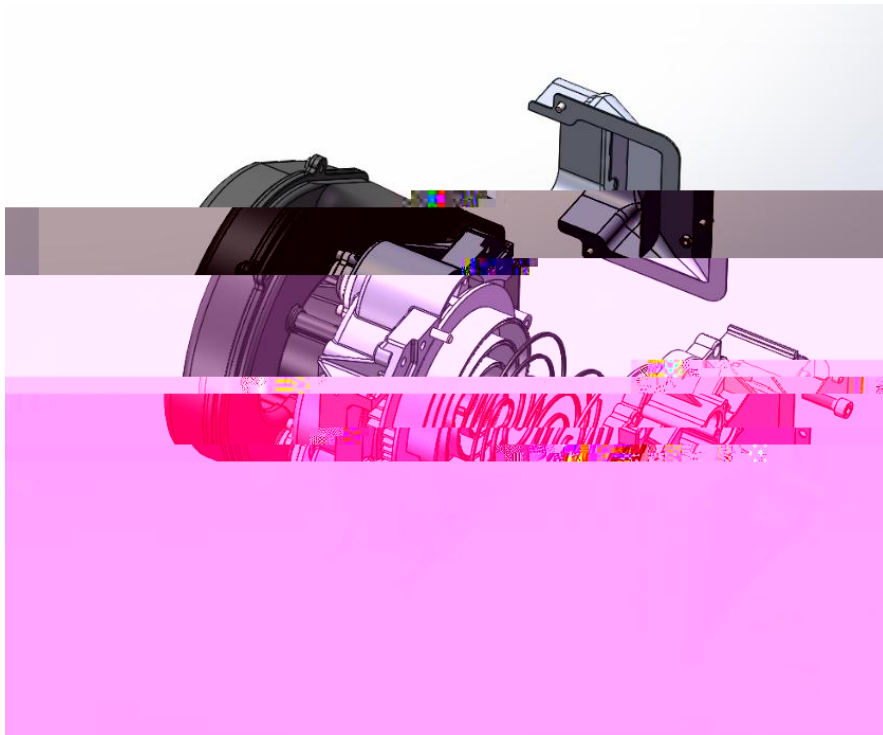
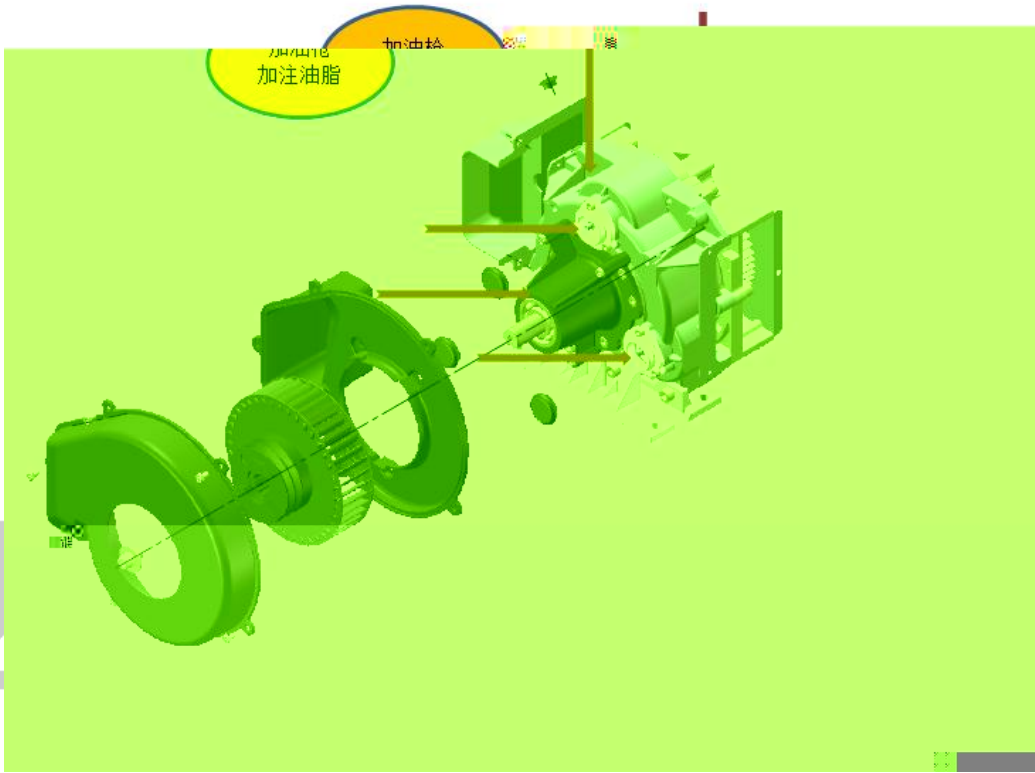

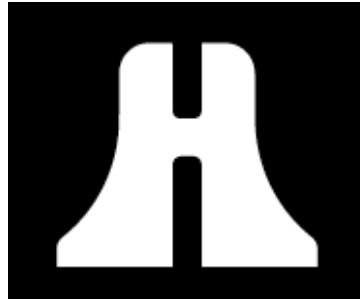

:400-770-2158

Tel:021-5735-0280
Fax:021-5136-8588

