

## RG 开启式螺杆压缩机



RG

RG

VI 2.6-5.6



R22 R717 R134a R502

R507 R170 R290 R1150 R1270

RE170

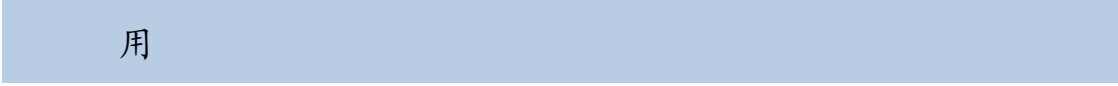

用

用 5 6

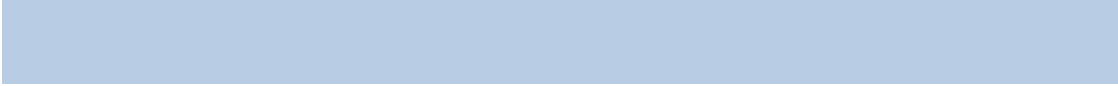

SKF

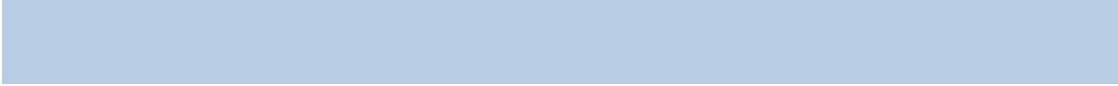

25% 100%



2.6 5.6 RG1150 2850

RG

		RG-200	RG-410	RG-620	RG-830	RG1150	RG1270	RG1800	RG2280	RG2850	
50Hz	m <sup>3</sup> /h	190	402	619	816	1146	1264	1761	2270	2851	
	Rpm	4500					3600				
	Rpm	1500									
		25% 100%									
VI		2.6 5.1				2.6~5.6					
	kg	232	320	475	513	1000	1166	1600	1720	1900	

## ECO

		RG200,R22						
		-50	-40	-30	-20	-10	0	10
30	(kW)	19.9	35.1	56.2	86.2	128.1	184.7	259.2
	(kW)	21.1	24.1	27.3	30.5	33.5	36.3	38.5
	(A)	36.1						

RG200,R717								
		-50	-40	-30	-20	-10	0	10
30	(kW)	15.9	29.7	50.7	82.2	127.2	188.6	269.5
	(kW)	21.5	23.8	26.9	30.3	33.4	35.6	36.4
	(A)	36.7	40.6	45.9	51.7	57.0	60.8	62.1
	COP	0.743	1.248	1.886	2.713	3.807	5.295	7.411
35	(kW)	14.7	28.2	48.6	79.2	122.8	182.6	261.5
	(kW)	23.7	26.0	29.3	33.1	36.7	39.6	41.2
	(A)	40.4	44.3	50.0	56.5	62.6	67.6	70.3
	COP	0.623	1.084	1.659	2.393	3.347	4.612	6.351
40	(kW)	13.3	26.5	46.3	75.9	118.3	176.4	253.5
	(kW)	26.1	28.4	31.9	36.0	40.1	43.7	46.1
	(A)	44.5	48.5	54.5	61.5	68.5	74.6	78.7
	COP	0.510	0.931	1.451	2.108	2.947	4.039	5.498
45	(kW)	--	24.5	43.8	72.4	113.5	170.1	245.2
	(kW)	--	31.1	34.7	39.1	43.7	47.9	51.2
	(A)	--	53.1	59.3	66.8	74.7	81.8	87.3
	COP	--	0.789	1.260	1.850	2.596	3.549	4.793
50	(kW)	--	--	41.0	68.7	108.5	163.5	236.7
	(kW)	--	--	37.8	42.5	47.5	52.3	56.3
	(A)	--	--	64.6	72.6	81.2	89.4	96.2
	COP							

		RG410,R22						
		-50	-40	-30	-20	-10	0	10
30	(kW)	42.4	74.7	119.5	183.2	272.1	392.5	550.7
	(kW)	43.9	50.1	56.7	63.4	69.7	75.4	80.1
	(A)	75.0	85.6	96.8	108.2	119.1	128.8	136.8
	COP	0.965	1.490	2.107	2.891	3.902	5.203	6.873
35	(kW)	38.7	70.0	113.0	174.0	259.3	375.2	528.1
	(kW)	46.7	54.2	61.7	68.9	75.5	81.1	85.4
	(A)	79.7	92.4	105.3	117.6	128.9	138.5	145.8
	COP	0.829	1.293	1.832	2.525	3.434	4.625	6.185
40	(kW)	34.7	64.9	106.0	164.2	245.9	357.3	504.8
	(kW)	49.7	58.6	67.1	75.1	82.1	87.8	91.7
	(A)	84.9	100.0	114.6	128.2	140.1	149.8	156.6
	COP	0.697	1.109	1.579	2.186	2.995	4.071	5.502
45	(kW)	--	59.4	98.5	153.9	231.8	338.6	480.7
	(kW)	--	63.5	73.2	82.1	89.6	95.4	99.3
	(A)	--	108.3	125.0	140.1	152.9	162.9	169.5
	COP	--	0.936	1.345	1.875	2.588	3.548	4.841
50	(kW)	--	--	90.5	143.0	217.2	319.4	455.9
	(kW)	--	--	80.1	89.9	98.1	104.3	108.2
	(A)	--	--	136.7	153.5	167.5	178.1	184.6
	COP	--	--	1.131	1.590	2.214	3.062	4.215

RG410,R717								
		-50	-40	-30	-20	-10	0	10

		RG620,R22						
		-50	-40	-30	-20	-10	0	10
30	(kW)	64.8	114.2	182.8	280.3	416.3	600.5	842.5
	(kW)	65.9	75.2	85.1	95.1	104.6	113.1	120.2
	(A)	112.5	128.4	145.3	162.3	178.6	193.2	205.2
	COP	0.984	1.519	2.149	2.948	3.980	5.307	7.010
35	(kW)	59.2	107.1	172.9	266.2	396.7	574.1	807.9
	(kW)	70.1	81.2	92.5	103.4	113.3	121.7	128.1
	(A)	119.6	138.7	157.9	176.5	193.4	207.7	218.7
	COP	0.845	1.319	1.869	2.575	3.502	4.717	6.308
40	(kW)	53.0	99.3	162.2	251.2	376.1	546.6	772.2
	(kW)	74.6	87.8	100.7	112.6	123.1	131.6	137.6
	(A)	127.3	150.0	171.9	192.3	210.2	224.7	234.9
	COP	0.711	1.131	1.610	2.230	3.055	4.152	5.611
45	(kW)	--	90.9	150.7	235.4	354.6	518.1	735.4
	(kW)	--	95.2	109.9	123.1	134.4	143.2	148.9
	(A)	--	162.5	187.5	210.1	229.4	244.4	254.3
	COP	--	0.955	1.372	1.912	2.639	3.619	4.937
50	(kW)	--	--	138.5	218.8	332.2	488.6	697.5
	(kW)	--	--	120.1	134.9	147.1	156.4	162.2
	(A)	--	--	205.1	230.2	251.2	267.1	277.0
	COP	--	--	1.153	1.622	2.258	3.123	4.299



RG830,R22								
		-50	-40	-30	-20	-10	0	10
30	(kW)	88.1	155.2	248.4	380.8	565.5	815.7	1144.6
	(kW)	86.4	98.6	111.6	124.7	137.2	148.4	157.6
	(A)	147.5	168.3	190.5	212.9	234.2	253.3	269.1
	COP	1.019	1.574	2.226	3.054	4.122	5.497	7.262
	(kW)	80.5	145.5	234.9	361.6	538.9	779.9	1097.6

RG830,R717

-50

-40

RG1270,R22

-50

-40

RG1270,R717								
		-50	-40	-30	-20	-10	0	10
30	(kW)	116.9	217.4	371.8	602.5	931.7	1381.6	1974.5
	(kW)	134.1	148.4	168.0	189.2	208.5	222.3	227.0
	(A)	228.9	253.3	286.8	323.0	356.0	379.6	387.5
	COP	0.872	1.465	2.214	3.184	4.468	6.214	8.698
35	(kW)	107.9	206.3	356.3	580.0	899.8	1337.8	1916.4
	(kW)	147.7	162.2	183.0	206.5	229.1	247.1	257.1
	(A)	252.1	276.9	312.4	352.5	391.0	421.9	438.9
	COP	0.731	1.272	1.947	2.809	3.928	5.413	7.454
40	(kW)	97.5	193.9	339.4	556.2	866.6	1292.9	1857.3
	(kW)	162.8	177.4	199.2	224.8	250.5	272.7	287.8
	(A)	278.0	302.8	340.2	383.8	427.7	465.6	491.4
	COP	0.559	1.093	1.703	2.474	3.459	4.741	6.452
45	(kW)	--	179.7	320.8	530.8	831.9	1246.4	1796.7
	(kW)	--	194.1	216.9	244.4	273.1	299.2	319.4
	(A)	--	331.4	370.3	417.3	466.2	510.8	545.2
	COP	--	0.926	1.479	2.172	3.047	4.165	5.626
50	(kW)	--	--	300.2	503.4	795.3	1198.2	1734.4
	(kW)	--	--	236.1	265.4	296.8	326.8	351.8
	(A)	--	--	403.1	453.1	506.7	557.9	600.5
	COP	--	--	1.272	1.897	2.680	3.666	4.930

RG200

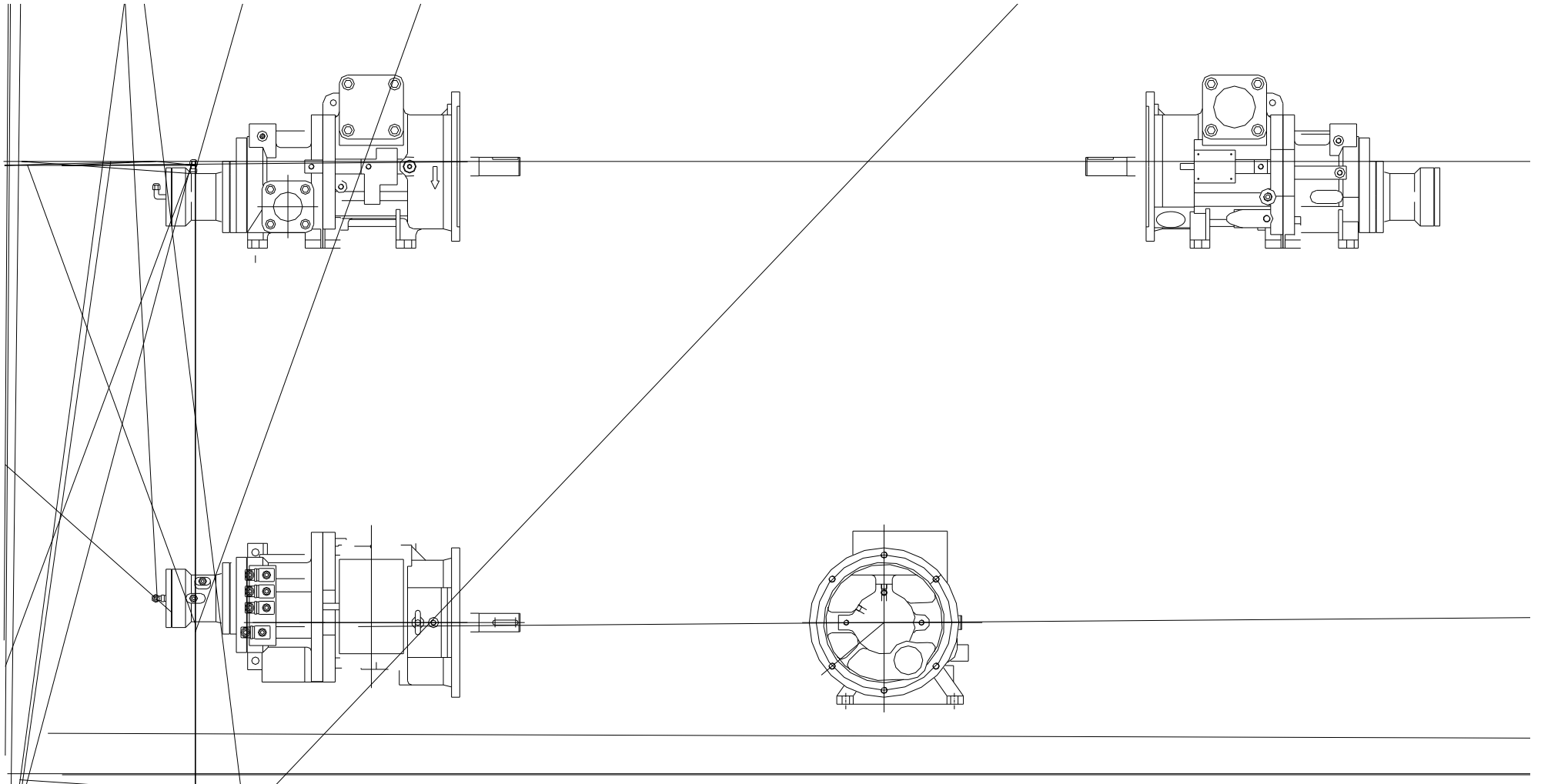

86186186129840230548612984045505 31224068455418612984083 10212825088612984088610455010371 3524 31 10 023 384048 0234384083 1048

RG410

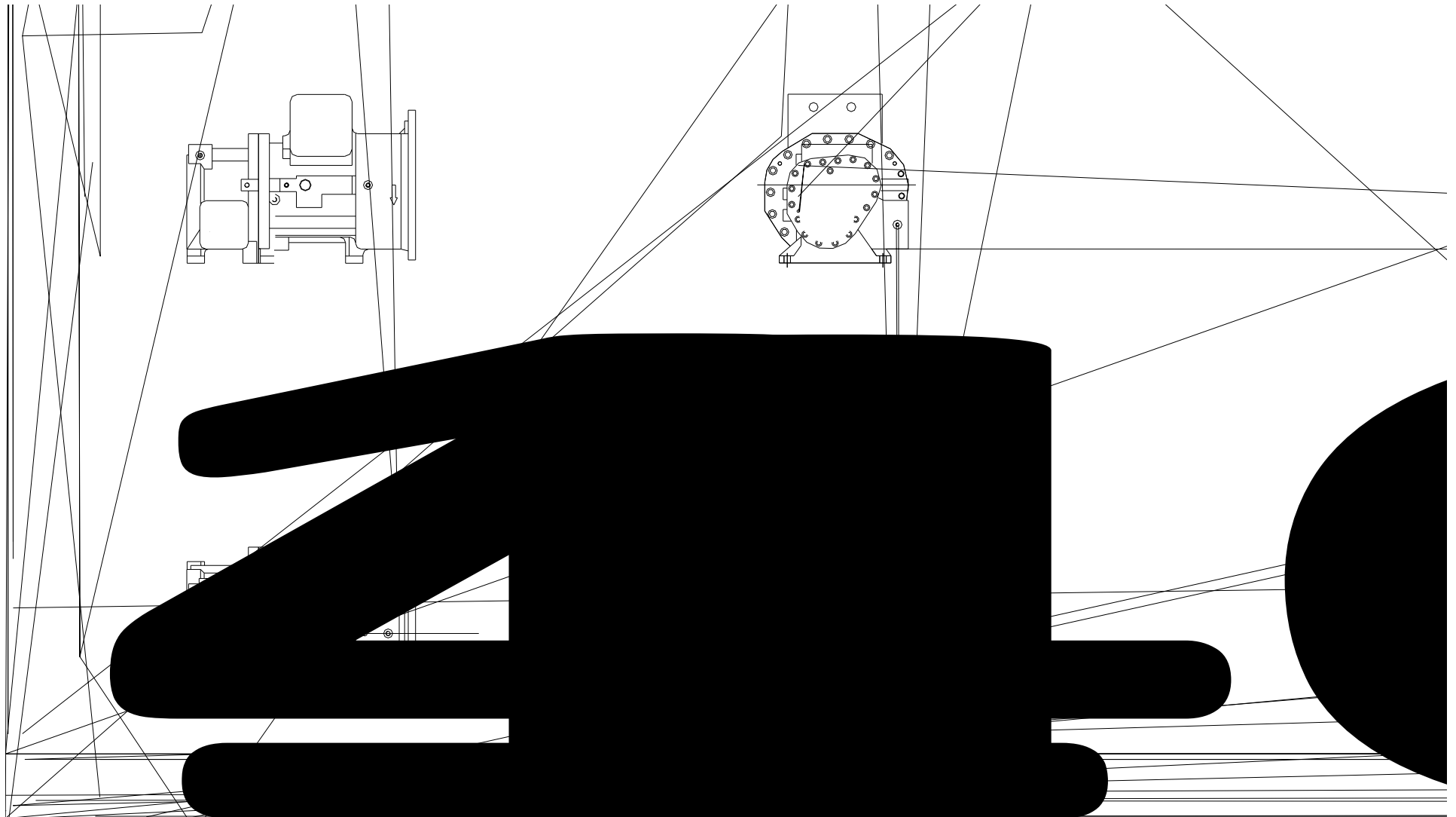

RG620

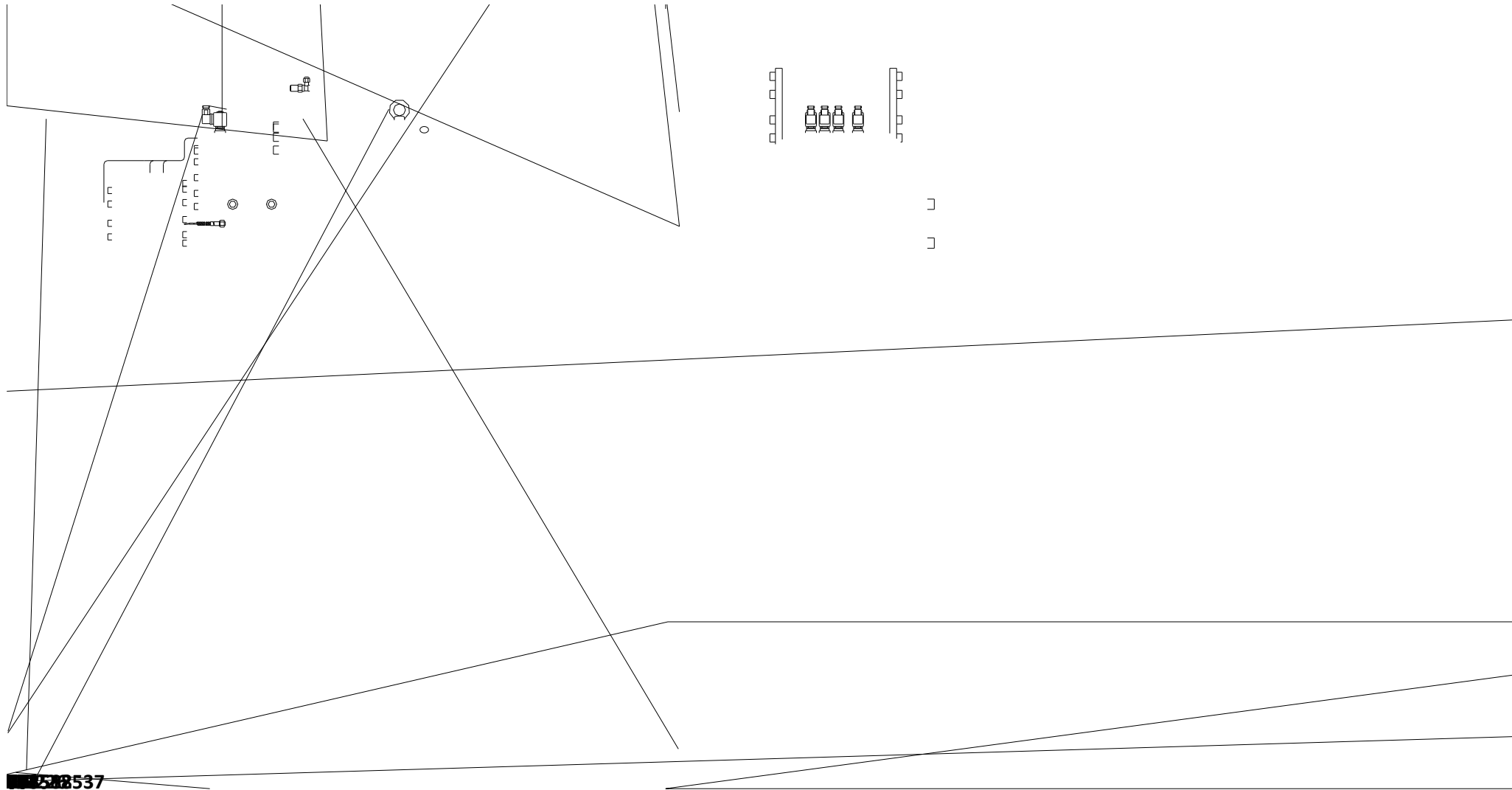

RG830

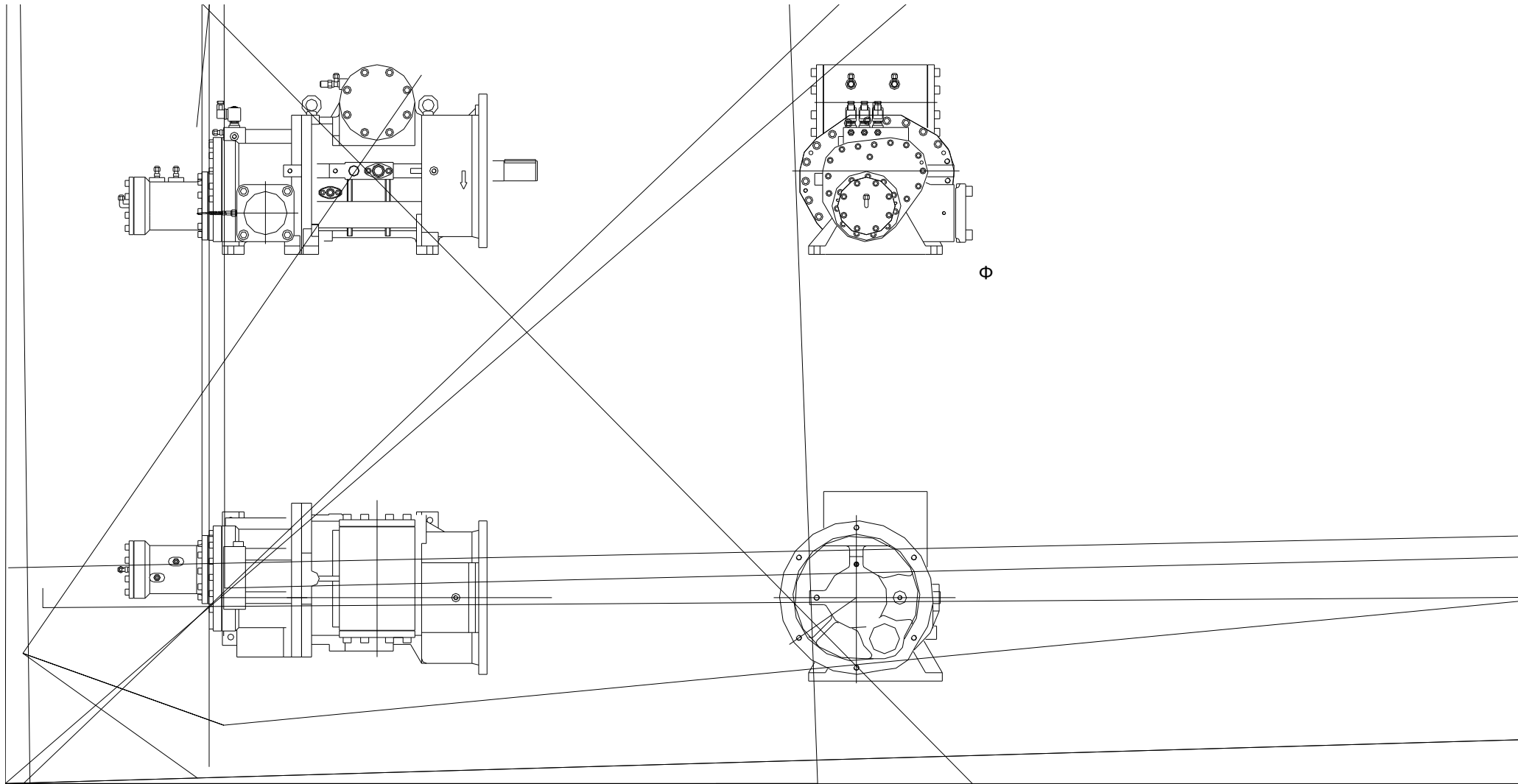

RG1150

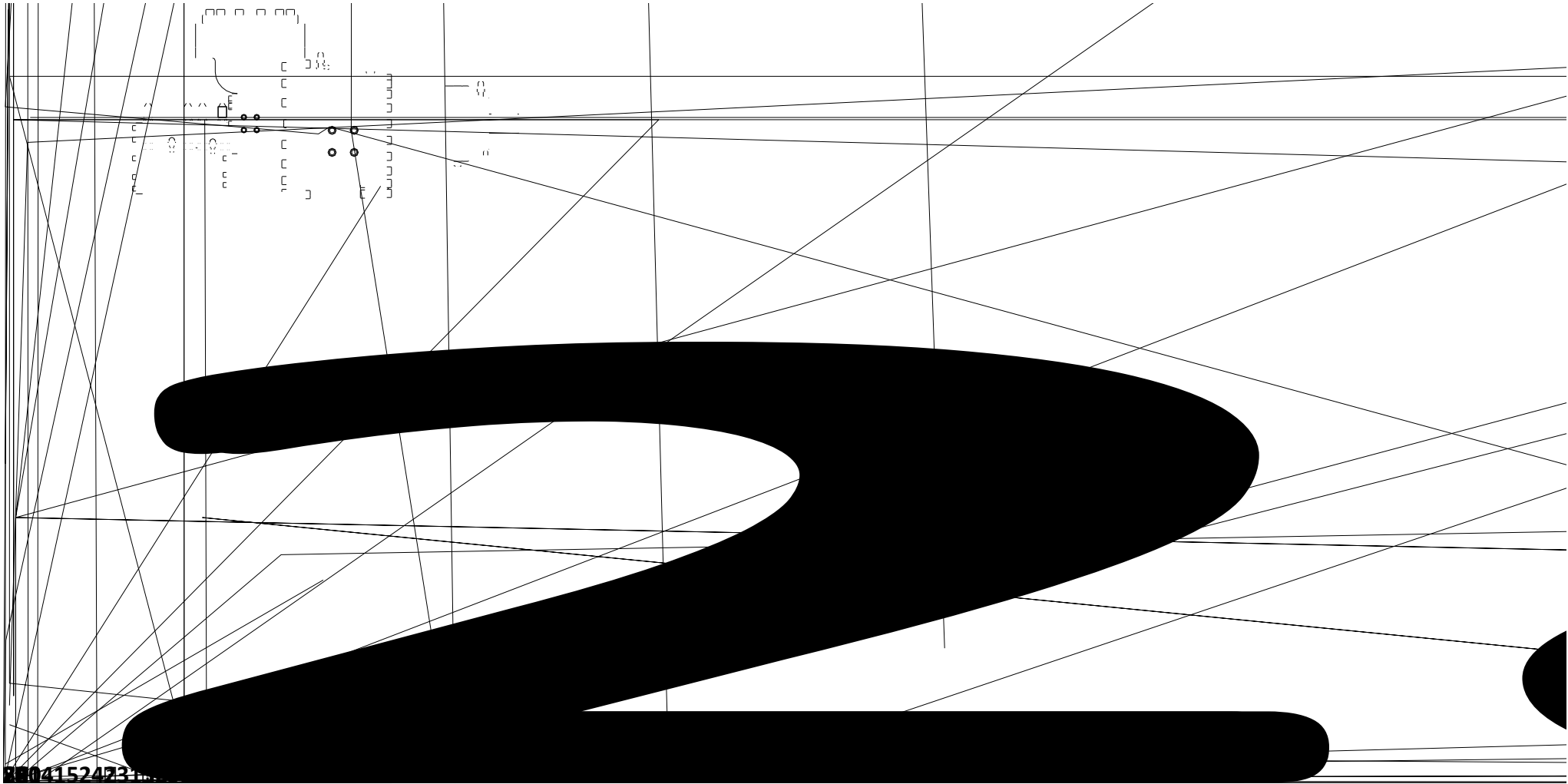

RG1152423

RG1270

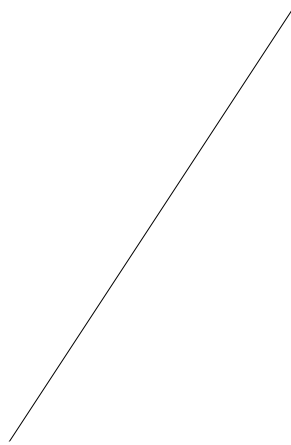
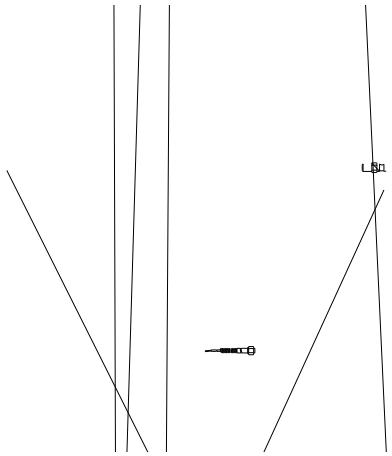

**RG1800**

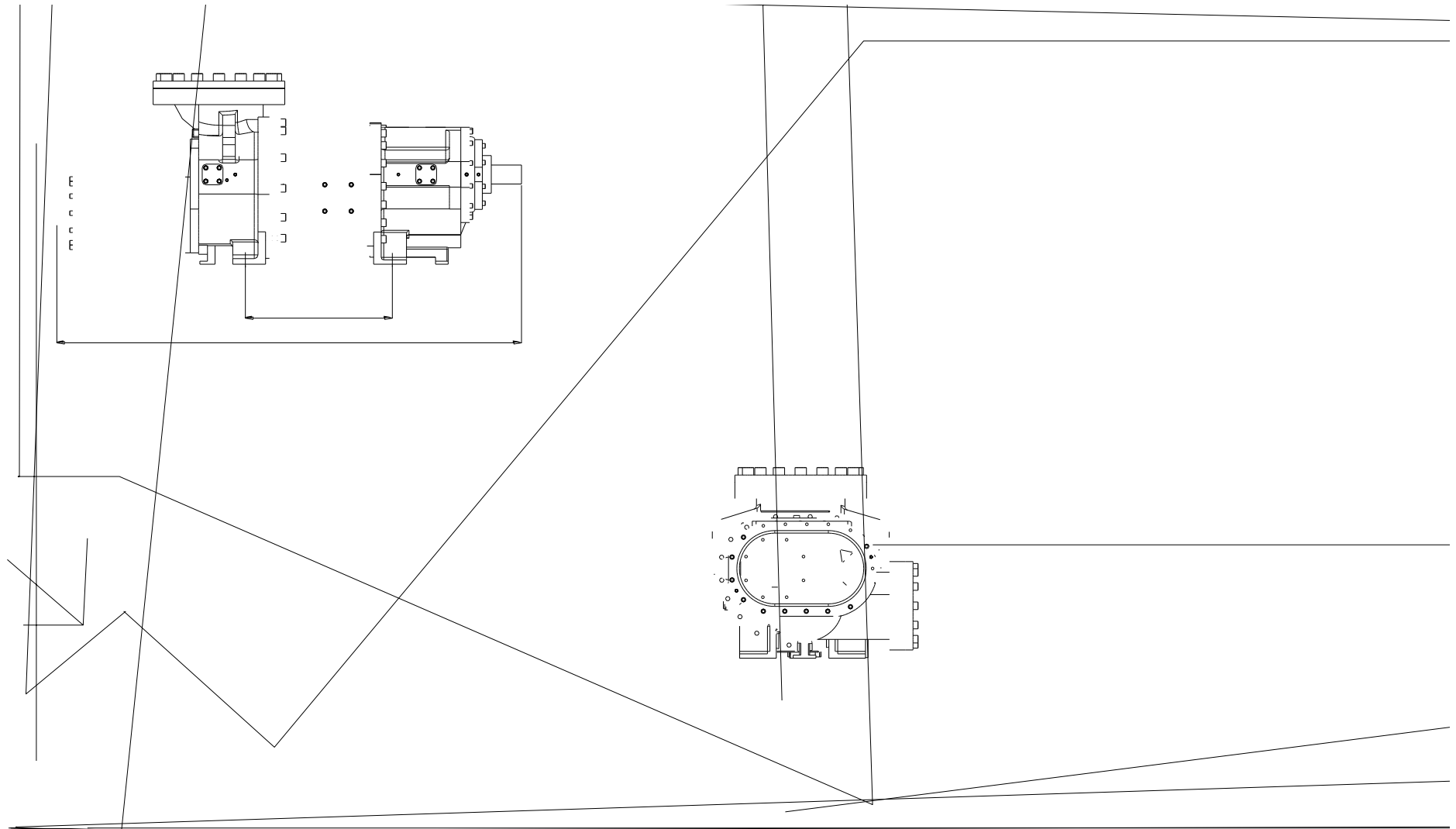

RG2280

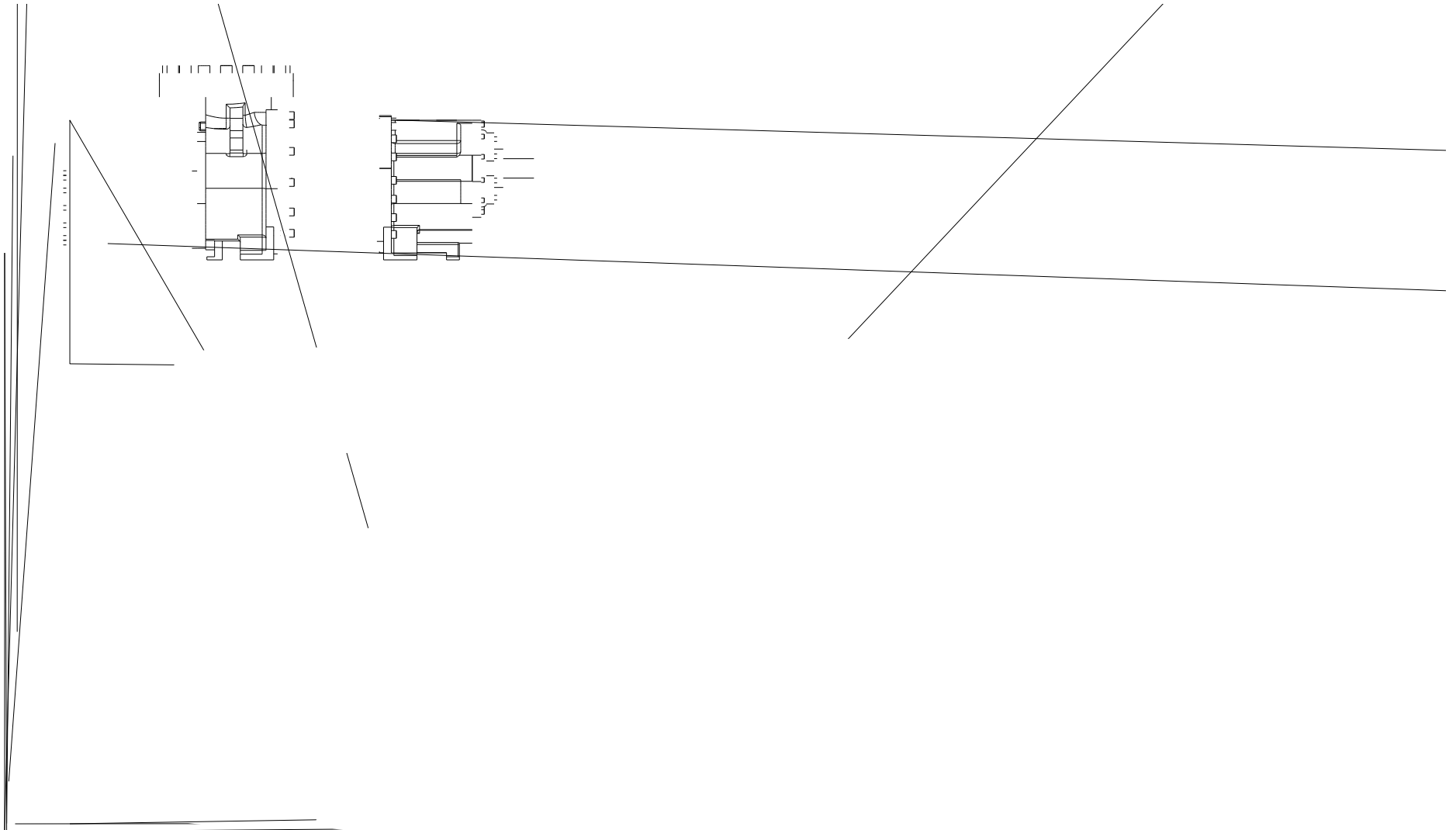



9  
9

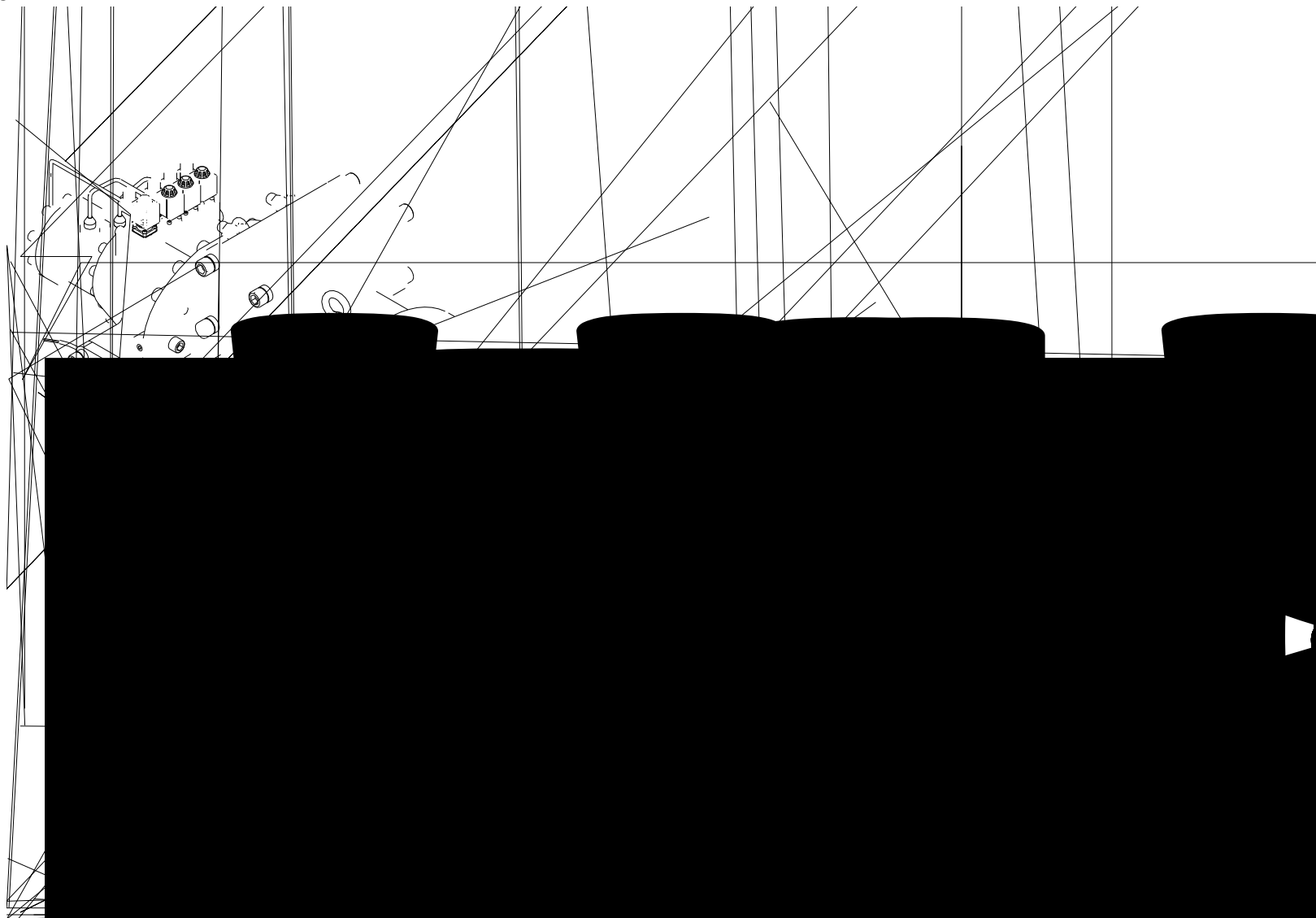

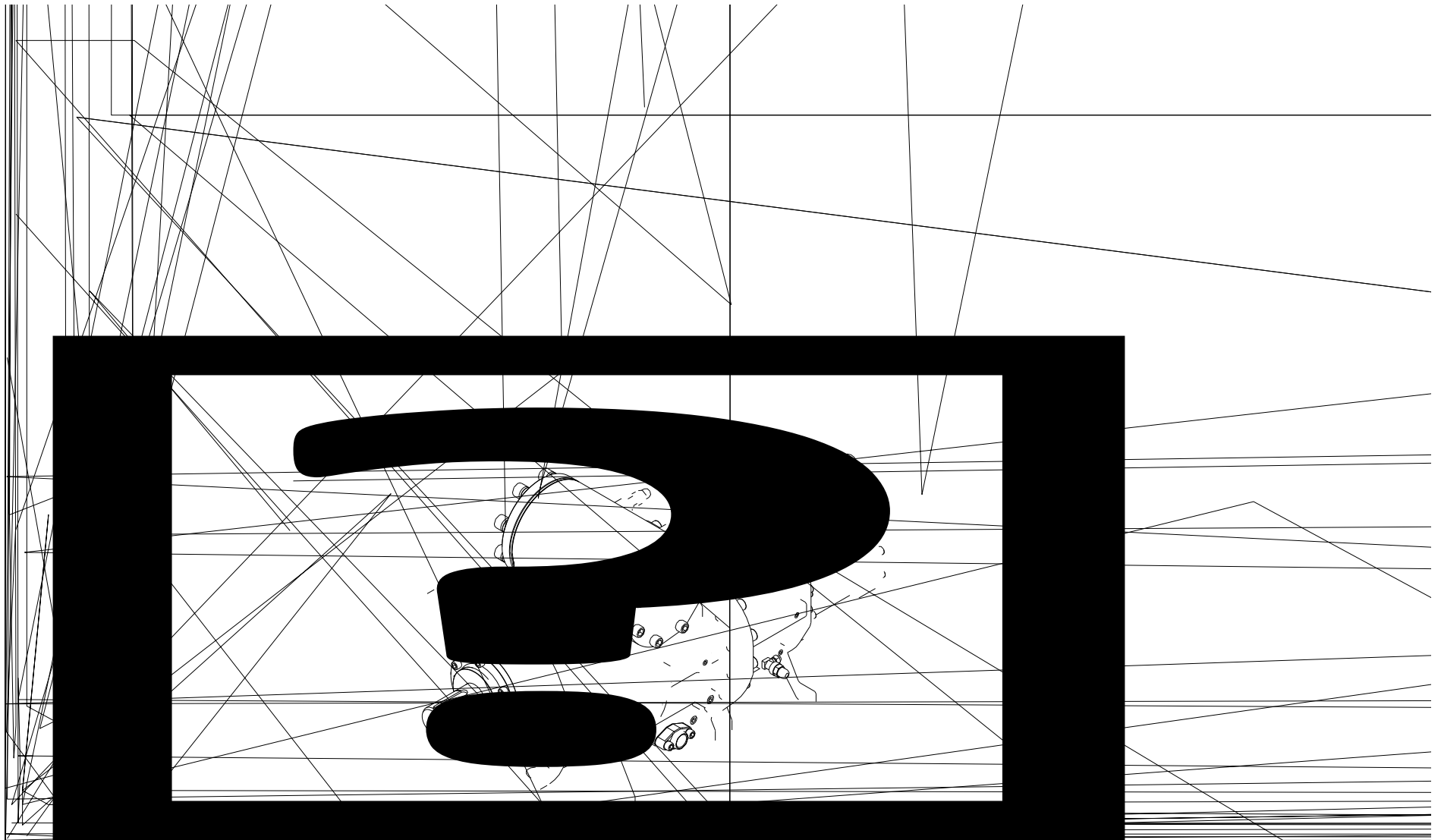

RG830





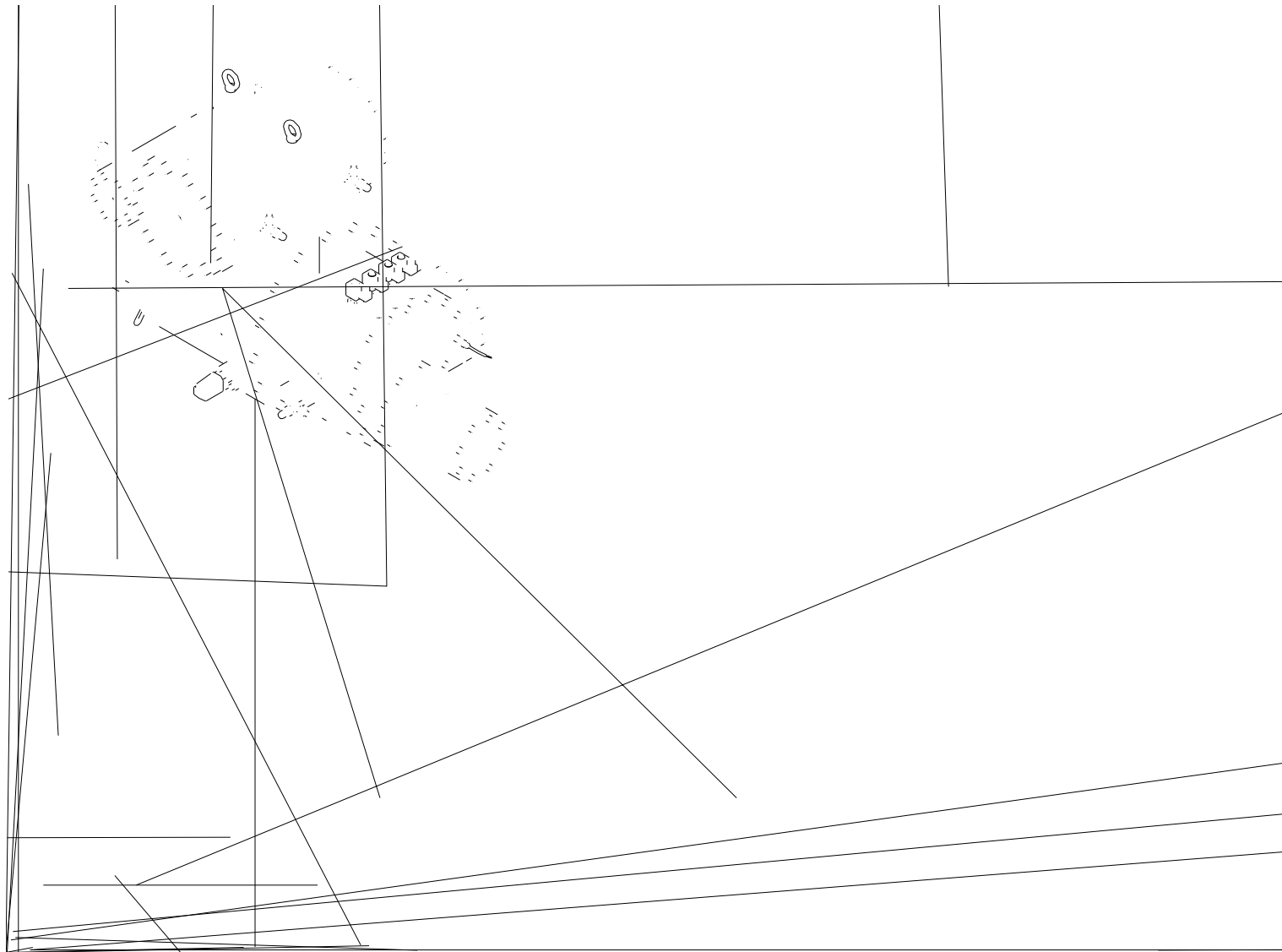

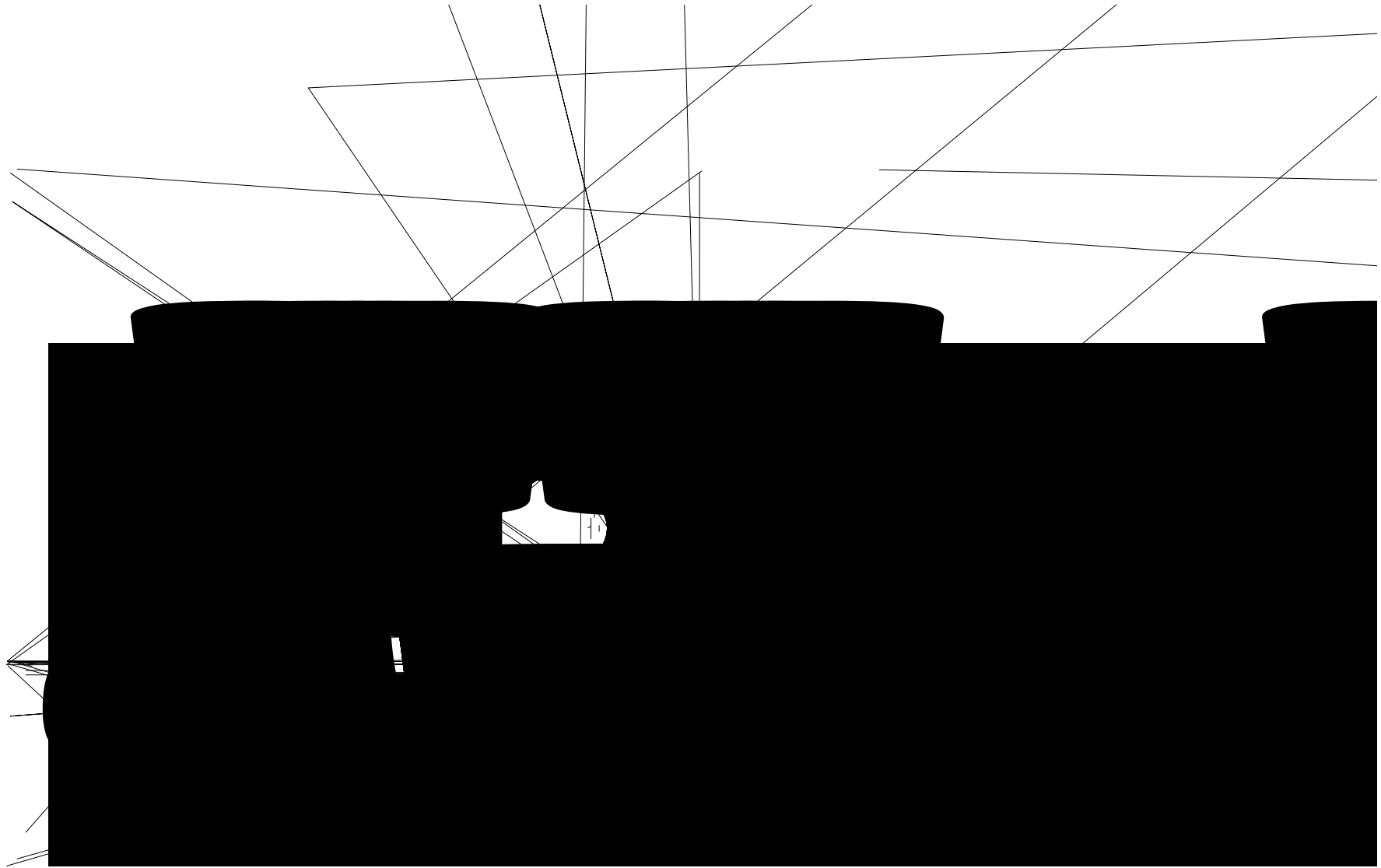

## RG

RG-200	2"	55	61.3	3"	80.5	90.2
RG-410	2 1/2"	68	77.2	4"	93	110
RG-620	3"	80.5	90.2	5"	106	135
RG-830	4"	93	110	5"	106	135
RG-1270	6"	159		8"	218	
RG1800	HANBELL					

